

Preface

Dear Customers:

Thank you for purchasing this brand new Uni-Trend instrument, for the purpose of using the instrument properly, we ask you to read this instruction manual carefully and thoroughly before putting this instrument into service, especially the sections related with "Safety Precautions". After you have read this instruction manual thoroughly, we suggest you place this instruction manual at a convenient location for future reference.

Limited Warranty Liability

Uni-Trend Technology (China) Limited will guarantee this product is free from any defect in material and process within one year from the date of purchase. This warranty is not applicable to fuse, disposable batteries, or any damage resulted from any accident, negligence, misuse, retrofitting, contamination, misoperation or handling. The dealer shall not be entitled to give any other warranty in the name of Uni-Trend. If warranty service is required within warranty period, please contact your nearest service center authorized by Uni-Trend to obtain authorized information on return of the product; then send the product together with the description of problems to that service center. This warranty is the only compensation that you can obtain. Otherwise, Uni-Trend will not provide any expressed or implied guarantee, such as the implied guarantee to certain specific item. Meanwhile, Uni-Trend will not be responsible for any special incidental or indirect damage or loss that is caused by any reason or speculation. As some areas or countries do not allow to implied guarantees and collateral or limit incidental or subsequent damage, above limitation of liability and stipulation may not applicable to you.

Content

I. Overview-----	1
II. Unpacking Inspection-----	1
III. Safe Operation Rules-----	2
IV. Features-----	5
V. Electrical Symbols-----	6
VI. Comprehensive Specifications-----	7
VII. Overall Configuration-----	8
VIII. LCD Display-----	9
IX. Knobs-----	10
X. Buttons-----	11
XI. Operating Instruction for Measuring-----	13
XII. Technical specifications-----	30
XIII. Maintenance and Repair-----	35

I. Overview

UT219E is three-proofing digital clamp meter specially designed for professional industrial users. The industrial design is rugged and durable, and capable of withstanding the impact from 2 meters' fall-down. The water proof rating is up to IP54; therefore, it can be used in environment with water splashing or much more dust. It is configured with LoZ (Low impedance input) AC voltage tap position, which is capable of testing the false voltage; auto backlight function can be used continuously under the circumstance of emergency power outage. UT219E is much more in compliance with the CAT IV 600V safety level, and certified by the German GS institution.

This Instruction Manual contains relevant safety information and warnings, read relevant contents carefully and strictly follow all warnings and precautions.

II. Unpacking Inspection

Take out the meter after unpacking, please inspect whether following accessories are missed or damaged or not, if any missing or damage is found, contact your supplier without any delay.

1. Instruction Manual----- 1 copy
2. Probe----- 1 pair

III. Safe Operation Rules

A) Safety certification

1. CE, TUV/GS certification: EN 61010-1: 2010 EN 61010-031: 2015 EN 61010-2-032: 2012 EN 61010-2-033: 2012 "Safety requirements for electrical equipment measurement, control laboratory use";
2. EN 61326-1:2013, EN 61326-2-2:2013 "Electrical equipment for measurement, control and laboratory use-EMC requirements"
3. CAT IV 600V, safety standard of pollution grade II and double insulation.

B) Prior to operation, read thoroughly the section "Safety operation rule", for the purpose of preventing electric shock or personal injury, carry out operation by following the guide below:

1. Carry out operation in accordance with the instructions in this manual, otherwise the protective measures for the meter may become invalid.
2. Do not use any damaged meter. Before using the meter, check the case of the meter for any crack or missed plastic part, special attention should be paid to the insulation around the joint.
3. Before putting the meter into operation, confirm that the battery cover has been closed and clamped. Before opening the battery cover, remove the test leads from the meter.
4. Inspect whether the insulation of the test leads is damaged or there is any exposed metal or not. Check whether the test leads are conductive or not. In case any damage with the conductor, use the meter only after replacement.
5. Do not measure any voltage or current which is higher than the allowable input value, when it is impossible to determine the range of the value to be measured, the function range switch should be set to maximum position. Before carrying out the

on-line test for resistance, Diode or circuit on/off, all power supplies in the circuit should be turned off in advance, and all capacitors should be discharged, otherwise the inaccurate measuring result may be caused.

6. In case the cover is removed or the cover is opened, do not use the meter.

7. Liquid crystal display shows “” symbol, replace the batteries timely to guarantee the measurement accuracy. Type 1.5 V AAA batteries should be used for supplying power for the meter, and care should be taken to install the batteries correctly.

8. The range switch should be set to a correct measuring position.

9. It is strictly forbidden to change the position of the range switch during the measuring to prevent the meter from being damaged.

10. When carrying out measuring, keep in mind not to extend your fingers over the hand-stopping location of the probes, do not touch any exposed conductor, connector, unused input terminal or the circuit under measuring to prevent electric shock.

11. After completion of each measuring operation, disconnect the probes from the tested circuit.

12. Replace the probes with same grade of CATIII1000V /CATIV600V or more probes.

13. If the voltage to be measured is DC 30 V or AC 30 Vrms, due care should be taken to avoid electric shock!

14. Do not use LoZ mode to measure the voltage in the circuit that may be damaged by the low impedance (300 kΩ) of this mode.

15. Do not use in high-temperature and high-humidity environment, especially do not store the meter in moisture environment, as the performance of moistened meter may become degraded.











16. Do not modify the internal wiring of the meter randomly so as not to damage the meter and jeopardize the safety!

17. When carrying out maintenance, please use wet cloth and gentle cleanser to clean the case of the meter, do not use lapping compound or solvent!

IV. Features

- 1) Fully enclosed, IP54 ingress protection,
- 2) Capable of withstanding fall-down from 2 meters' height,
- 3) Large LCD dual mode reading display, 6,000 counted dual slope analog-to-digital converter (UT219E conversion rate of 3 times/second)
- 4) Full function misoperation prevention, enabling to sustain lightning impulse voltage of 8kV and more.
- 5) True Root Mean Square (TRMS) AC voltage and current can measure the non-linear signal precisely.
- 7) Available to measure alternating current up to 600A frequency response is 40 Hz to 400 Hz.
- 10) LoZ voltage measurement, which provides low impedance along the conductor circuit to solve the problem of false voltage measuring.
- 11) The measurement range of capacitance for motor start capacitance or elements is 60.00 mF.
- 12) There is a special function measuring as MAX, MIN, relative value, data holding and etc.
- 13) Manual and auto selection range allows maximum flexibility.
- 14) Auto backlight function turns on and off the backlight adjustment automatically according to the intensity.

V. Electrical Symbols

Symbol	Meaning
	Double insulation
	Grounding
	Warning hint
	AC (Alternating current)
	DC (Direct current)
	Low battery in the unit
	Do not dispose this product as unclassified urban waste.
	High pressure alarm
	In compliance with EU directive
	Reviewed and approved by TÜV Product Services
CAT IV	IEC measurement category IV-CAT IV(CAT IV): The design of the device enables the device to subject to class 1 power rating, such as the transient voltage generated by kilo-watt-hour meter, overhead lines or downstream facilities.

VI. Comprehensive Specifications

1. The overload protection voltage between various input terminals and grounding is 600 V.
2. Maximum display: 6000 bits, UT219E upgrades 3 times per second. Over-range display "OL".
3. Range: MANUAL/AUTO
4. Polarity: Automatic positive and negative polarity display
5. Operating temperature and humidity: 0°C ~ 30°C (no more than 80% RH), 30°C ~ 40°C (no more than 75% RH), 40°C ~ 50°C (no more than 45% RH)
6. Storage temperature and humidity: -20°C ~ +60°C (no more than 80% RH)
7. Operating altitude: 0 ~ 2,000 m
8. Batteries in the unit 3 type 1.5V AAA alkaline batteries
9. If low batteries: LCD display "🔋" symbol.
10. Overall dimensions: 235×83×47 mm
11. Weight: 338 g (including batteries)
12. Electromagnetic compatibility:
 - Under 1V/m radio-frequency field: Total accuracy = specified accuracy + 5% of range, the indicator is not specified for the radio-frequency field of 1V/m and more.
13. Appraisal: CE, GS, TUV

VII. Overall Configuration

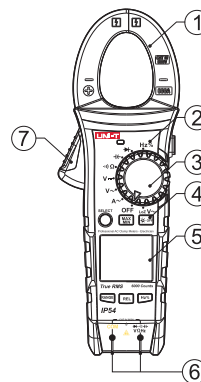

1. Jaw

It is the sensing device for measuring alternating current, enabling to convert current to voltage.

2. Clamp body

It is a safe design to prevent the hand of the user from getting contact with the dangerous area.

3. Rotary switch

It is used to select the function stall for measuring.

4. Function key

It is used to select basic features

5. LCD display area

It displays the measured data and function symbol.

6. Measurement input terminals

It is used for the input of the measured signal.

7. Jaw trigger

Press the trigger to open the jaws; release the trigger to close the jaws automatically.

VIII. LCD Display

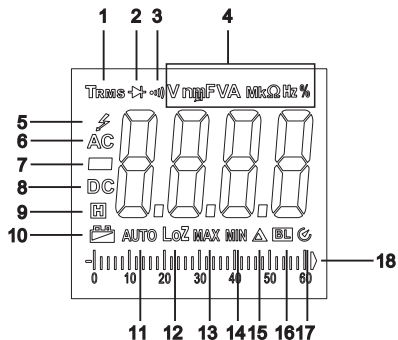

1. True root mean square prompt
2. Diode prompt
3. Circuit On/Off measuring prompt
4. Units prompt
5. High voltage alarm
6. AC signal prompt
7. Negative pole prompt
8. DC signal prompt
9. Holding symbol prompt
10. Low voltage prompt
11. AUTO range prompt
12. Low impedance measuring prompt
13. MAX measuring prompt
14. MIN measuring prompt
15. Relative Measurement prompt
16. Automatic backlight function prompt
17. Auto power off prompt
18. Analogue bar prompt

IX. Knobs

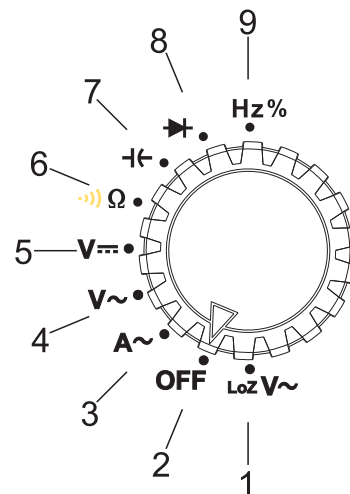

1. Low impedance AC voltage position
2. Meter OFF position
3. AC current position
4. AC voltage position
5. DC voltage position
6. Resistance position, continuity test position (Shortly press SELECT key for selection)
7. Capacitance position
8. Diode position
9. Frequency position and duty ratio position (Shortly press Hz% key for selection)

X. Buttons

1. RANGE

Press RANGE button once to enter MANUAL measurement mode and change the range. Press RANGE button for 2 seconds and more to change from Manual range to Auto range. This is only valid for AC/DC voltage, AC current, resistance and frequency measurement.

2. MAX/MIN

Press MAX/MIN button once, LCD will display "MAX" symbol, enter the MAX measurement mode and display the maximum value, if press it again, the LCD will display "MIN" symbol, enter the MIN measurement mode and display the minimum value. Repeat in this order. Press this button for at least 2 seconds to exit the MAX/MIN measurement. This is only valid for AC/DC voltage, AC current, resistance, temperature, capacitance measurement on main display.

3. REL/ZERO

- Press REL button once to enter MANUAL range mode, LCD will display "△" symbol and take the existing displayed values as reference, then it displays the difference between the measured value and the referential values. This is only valid for measurement of AC/DC voltage, AC current, resistance and frequency.

4. HOLD button

Press this button once, the displayed values will be locked and held, LCD will display "■" prompt, if press it again, the locking is released and enters normal measurement mode. This is suitable for full range.

5. A-OFF

It turns off the auto backlight function, if restart is required, rotate the function switch to OFF position to turn it on again.

6. Hz%



In AC voltage/AC current measurement mode, press "Hz%" button once to enter frequency measurement mode, press "Hz%" button again to enter Duty Ratio mode.

In Frequency/Duty Ratio measurement mode, press "Hz%" button once to enter Duty Ratio measurement mode, press "Hz%" button again to enter frequency mode.

7. SELECT

- Press SELECT button once to select combined function of the position.
- Pressing and holding SELECT button while turning the unit on cancels Auto-OFF function.

XI. Operating Instruction for Measuring

First, inspect 3 type 1.5V AAA batteries in the unit, if the instrument is turned on with low batteries, the screen will display “” symbol, it can be used only after the batteries are replaced. Attention should also be paid to the symbol “” beside the probe sockets, this is to warn you of not exceeding the indicated number for the voltage to be tested so as to guarantee the safety of testing!

1. AC Current measurement

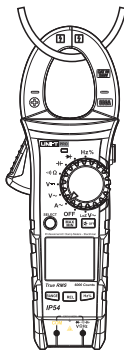

- 1) Set the switch to “A~” function position, press down and hold conductor to be tested, then release the trigger slowly till the jaws are fully closed, please confirm whether the conductor to be tested is centrally clamped between the jaws,

Otherwise, additional error will be caused, only an individual current conductor can be measured once for the clamp meter, the measured readings will be erroneous if two or more current conductor are measured simultaneously.

- 2) press “HZ%” button to read the frequency and duty ratio.

Notes:

- The current measurement function should only be operated from 0°C to 40°C, in case of positive reading, the direction of current is from up to down (panel is up while bottom cover is down). Press down and hold the trigger without releasing it suddenly, as the Hall elements is a kind of sensitive devices, besides it is sensitive to magnetic, it also has different sensitivity to thermal and mechanical stresses, collision can results in reading change in short time.
- To guarantee the measured data to be accurate, the conductor to be tested should be located at the center of the jaws, otherwise an additional error of $\pm 1.0\%$ reading will be caused.

2. AC Voltage measurement

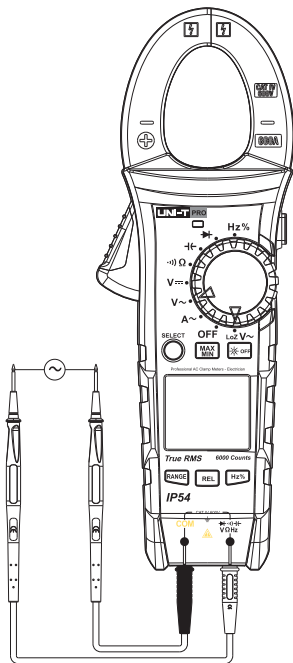

- 1) Insert the red probe into “V” socket; insert the black probe into “COM” socket.
- 2) Set the functional range switch to “V~”, select the measuring range of AC voltage, and parallelly connect the probes to the power supply or load to be measured.
- 3) press “HZ%” button to read the frequency and duty ratio.
- 4) Set the functional range switch to “LozV~” position, select low impedance AC voltage measurement, its resistance is about 300 kΩ, which can prevent the impact of the virtual voltage.

⚠ Note:

- Do not input a voltage that is more than 600 Vrms. As there is the possibility to measure much higher voltage, but the risk to damage the instrument exists!
- In case of measuring high voltage, special attention should be paid to prevent the risk of electric shock!
- After completion of all measuring operation, disconnect the probes from the tested circuit.
- When the measured voltage is higher than 30V/AC safe voltage, the LCD of this instrument will display high voltage warning prompt “⚡”, in case of over-voltage input: when it is more than AC 600 V range, this instrument will automatically buzz intermittent sound and the high voltage warning prompt ⚡ will flash to prompt the warning!

3. Direct-voltage measurement.

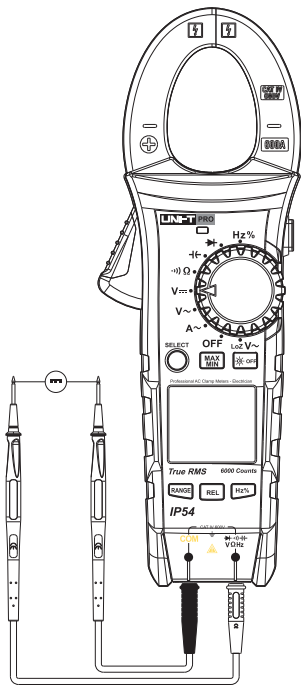

- 1) Insert the red probe into "V" socket; insert the black probe into "COM" socket.
- 2) Set the functional range switch to "V=", pressing SELECT button selects the measuring range of DC voltage, and parallelly connect the probes to the power supply or load to be measured.
- 3) Read the DC Voltage value from the display.

⚠ Notes:

- Do not input a voltage that is more than 600 V. As there is the possibility to measure much higher voltage, but the risk to damage the instrument exists!
- In case of measuring high voltage, special attention should be paid to prevent the electric shock.
- After completion of all measuring operation, disconnect the probes from the tested circuit.
- When the measured voltage is higher than 30V/DC safe voltage, the LCD of this instrument will display high voltage warning prompt "⚡", in case of over-voltage input: when it is more than DC 600 V range, this instrument will automatically buzze intermittent sound and the high voltage warning prompt ⚡ will flash to prompt the warning!

4. Resistance measurement

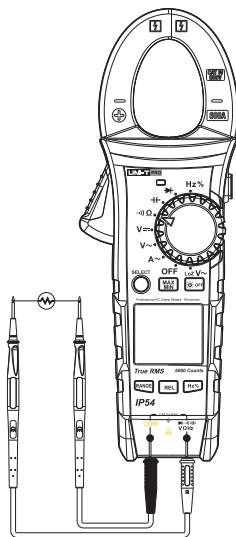

- 1) Insert the red probe into “Ω” socket; insert the black probe into “COM” socket.
- 2) Set the functional range switch to “Ω”, press SELECT button to select the measuring range of resistance, and parallelly connect the probes to both ends of the resistance to be measured.
- 3) Read the value of resistance to be measured directly from the display.

⚠ Notes:

- If the resistance to be measured is open circuit or the value of resistance is more than the maximum range of the instrument, the “OL” will be displayed.
- When measuring the on-line resistance, turn off all power supplies in the circuit to be measured and discharge all residual charges on all capacitors before carrying out measurement. In this way, the correct measuring can be assured.
- In case of low resistance measuring, there is an additional error of about 0.1 Ω to 0.2 Ω resistance. To obtain the precise reading, the relative measurement function can be used, first short circuit the input probes and press REL button, carry out low resistance measurement after the instrument has subject the indicated value when shorting circuit the probes.
- If the resistance value is not less than 0.5 Ω when shortening circuit of probes, check for any loosening or other causes with the probes.
- When measuring high resistance, the reading will become stable after time duration of few seconds. This is normal for high resistance measuring.
- Do not input DC or AC 30 V and more voltage to prevent from personal injury.
- After completion of all measuring operation, disconnect the probes from the tested circuit.

5. Conductivity testing

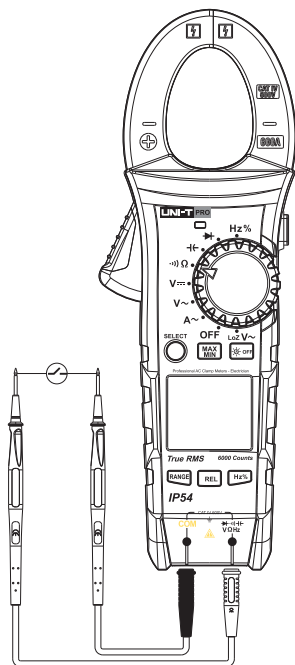

- 1) Insert the red probe into “ Ω ” socket, insert the black probe into “COM” socket.

- 2) Set the functional range switch to “ Ω ”, press SELECT button to select the measuring range of resistance, and parallelly connect the probes to both ends of the load to be measured. If the resistance between both ends is less than 10Ω , the circuit is considered as breakover, the buzzer will sound continuously. In case the resistance is more than 50Ω , the buzzer will not give any sound.
- 3) Read the value of resistance value of load for the circuit to be measured directly from the display.

⚠ Notes:

- When inspecting the on-line circuit conductivity, turn off all power supplies in the circuit to be measured and discharge all residual charges on all capacitors before carrying out measurement.
- For circuit conductivity measuring, the open circuit voltage is about -3.2 V more or less, the range is 100Ω measurement.
- Do not input DC or AC 30 V and more voltage to prevent from personal injury.
- After completion of all measuring operation, disconnect the probes from the tested circuit.

6. Diode measuring

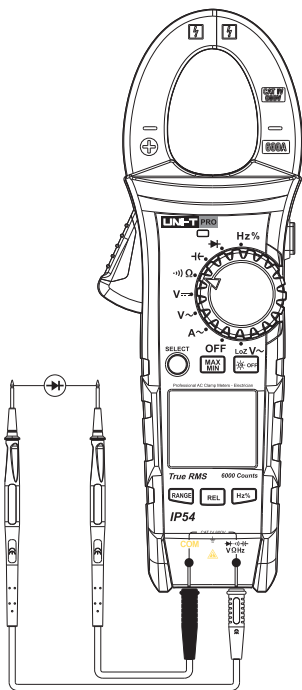

- 1) Insert the red probe into “▶” socket, insert the black probe into “COM” socket. The polarity of the red probe is “+”, the polarity of the black probe is “-”.
- 2) Set the function switch to “▶” measurement position, press SELECT button to select diode measurement ▶, read the positive PN-junction voltage of the diode to be measured directly from the display. For silicon PN-junction, it will be confirmed to be normal value if the reading is about 500 to 800 mV.

⚠ Notes:

- If the diode to be measured is open circuit or the polarity is reverse, “OL” will be displayed.
- When measuring the on-line diode, turn off all power supplies in the circuit to be measured and discharge all residual charges on all capacitors before carrying out measurement.
- The open circuit voltage of diode in UT219E is about 10 V more or less, voltage value for voltage stabilizing diode can be measured (less than 9 V).
- Do not input DC or AC 30V and more voltage to prevent from personal injury.
- After completion of all measuring operation, disconnect the probes from the tested circuit.

7. Capacitance measurement

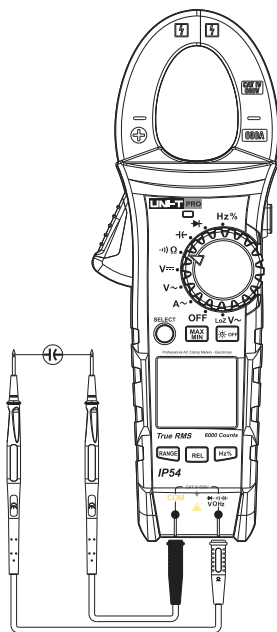

- 1) Insert the red probe into “+” socket, insert the black probe into “COM” socket.
- 2) Set the range switch to “C” measurement position, press SELECT button to select the measuring range of resistance, and parallelly connect the probes to both ends of the resistance to be measured.
- 3) Read the value of capacitance value of load for the circuit to be measured directly from the display.

⚠ Notes:

- If the capacitance to be measured is short circuit or the value of capacitance is more than the maximum range of the instrument, the “OL” will be displayed.
- In the capacitance measurement mode, the cursor of analog bar is deactivated. For the measurement of capacitance of more than 600 μF , it will take much longer time so as to generate correct reading.
- For the purpose of guaranteeing the measurement resolution, it is suggested to fully discharge the residual charges before measuring, then connect with the instrument for measurement, this is much more important for high voltage capacitance to prevent the instrument from being damaged and personal injury.
- After completion of measuring operation, disconnect the probes from the tested capacitance.

8. Frequency/duty ratio measurement

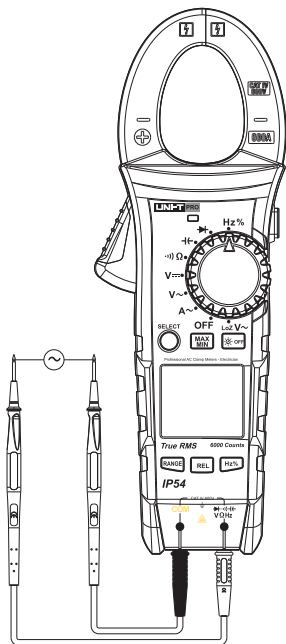

- 1) Insert the red probe into “Hz” socket; insert the black probe into “COM” socket.
- 2) Set the functional range switch to “Hz%” measurement position, parallelly connect the probes to the signal source to be measured.
- 3) Press “Hz%” button once to enter Duty Ratio measurement mode, press “Hz%” button again to enter frequency measurement mode.

⚠ Note:

- The requirement for input amplitude (a) should be met in frequency measurement:
 - ≤100 kHz: $200 \text{ mVrms} \leq a \leq 20 \text{ Vrms}$
 - > 100 kHz~1 MHz: $600 \text{ mVrms} \leq a \leq 20 \text{ Vrms}$
 - > 1 MHz~10 MHz: $1 \text{ Vrms} \leq a \leq 20 \text{ Vrms}$
 - > 10 Mhz: $1.8 \text{ Vrms} \leq a \leq 20 \text{ Vrms}$
- Following requirements should be satisfied in duty ratio measurement:
 - The waveform is square wave, and frequency $\leq 10 \text{ kHz}$
 - the amplitude: $2 \text{ Vpp} \leq \text{Input amplitude} \leq 20 \text{ Vpp}$
- Do not input 30 Vrms and more voltage for the frequency to be measured to prevent from personal injury.
- After completion of all measuring operation, disconnect the probes from the tested circuit.

9. Other functions

● Auto-Shutoff function:

If any knob switch is not operated or any button is not pushed within about 15 minutes, the instrument will turn on the auto-shutoff function to save energy. In the auto power off state, click any button or turn the knob switch, the instrument will be waken up automatically.

The auto-shutoff feature will be canceled when powering on again after pressing SELECT button in shutdown state. It will be necessary to restart the unit to restore the Auto-off function.

● Auto backlight:

In case the instrument is placed in a dark environment after turning it on, the backlight function will be turned on immediately. If the instrument is placed in a bright environment again, the backlight function will be turned off in 30 seconds.

In addition, the auto backlight function will be turned off after pressing OFF button while the backlight is on, if it is necessary to restart the backlight function, just turn off the unit and turn it on again.

● Low voltage testing: Detect the internal VDD while the power is supplied, when it is less than 3 V, “” low battery symbol will be displayed.

XII. Technical specifications

Accuracy: $\pm(a\%$ reading $+b$ digit), the warranty period is one year.

Ambient temperature: 23°C to 5°C (73.4°F \pm 9°F)

Relative humidity: $\leq 75\%$

Note:

Accurate temperature condition is 18°C to 28°C, the ambient temperature fluctuation range is stable in $\pm 1^\circ\text{C}$. If the temperature $< 18^\circ\text{C}$ or $> 28^\circ\text{C}$, the additional temperature coefficient error is $0.1 \times (\text{specified accuracy})/^\circ\text{C}$.

1. AC current

Range	Resolution	Accuracy		Overload protection
		40Hz~100Hz	100Hz~400Hz	
60.00A	0.01A	$\pm(1.8\%+6)$	$\pm(3.5\%+6)$	600A
600.0A	0.1A			

● Display: True root mean square: Suitable to a range of 5% to 100%.

● Frequency response: 40 Hz~400 Hz, frequency measurement is suitable to a range of 10% to 100%.

● The AC wave peak factor is up to 3.0 in full value, the accuracy of non-sine wave should be adjusted based on following conditions:

Wave peak factor 1.0 to 2.0 The accuracy should be increased by 3.0%

Wave peak factor 2.0 to 2.5 The accuracy should be increased by 5.0%

Wave peak factor 2.5 to 3.0 The accuracy should be increased by 7.0%

2. AC voltage

Range	Resolution	Accuracy	Overload protection
6.000V	0.001V	± (1.0%+6)	600V DC 600V AC
60.00V	0.01V		
600.0V	0.1V		

- Input impedance: the input impedance is about 10 MΩ.
- Display true root mean square, suitable to a range of 5% to 100%.
- Frequency response: 40 Hz~400 Hz, the frequency measurement is suitable to a range of 10% to 100%.
- The AC wave peak factor is up to 3.0 in full value (except 600 V range, 1.5 in case of this full range value) for non-sine waveform, the accuracy of non-sine wave should be adjusted based on following conditions:
Wave peak factor 1.0 to 2.0 The accuracy should be increased by 3.0%
Wave peak factor 2.0 to 2.5 The accuracy should be increased by 5.0%
Wave peak factor 2.5 to 3.0 The accuracy should be increased by 7.0%

3. LoZ AC voltage

Range	Resolution	Accuracy	Overload protection
600.0V	0.1V	± (2.5%+6)	600V DC 600V AC

- Input impedance: the input impedance is about 300 kΩ.
- Display true root mean square, suitable to a range of 5% to 100%.
- Frequency response: 40Hz~400Hz, the frequency measurement is suitable to a range of 10% to 100%.
- The AC wave peak factor is up to 1.5 in full value, the accuracy of non-sine wave should be adjusted based on following conditions:
Wave peak factor 1.0 to 2.0 The accuracy should be increased by 3.0%
Wave peak factor 2.0 to 2.5 The accuracy should be increased by 5.0%
Wave peak factor 2.5 to 3.0 The accuracy should be increased by 7.0%
- The measuring time should not exceed 1 minute

4. DC voltage

Range	Resolution	Accuracy	Overload protection
600.0mV	0.1mV	± (0.8%+3)	600V DC 600V AC
6.000V	0.001V	± (0.6%+3)	
60.00V	0.01V	± (0.9%+6)	
600.0V	0.1V		

- Input impedance: the input impedance is about 10 MΩ

5. Resistance measurement

Range	Resolution	Accuracy	Overload protection
600.0Ω	0.1Ω	± (1.3%+3)	600V DC 600V AC
6.000kΩ	1Ω	± (1.0%+3)	
60.00kΩ	10Ω		
600.0kΩ	100Ω		
6.000MΩ	1kΩ	± (1.6%+4)	
60.00MΩ	10kΩ	± (2.6%+7)	

6. Conductivity test (••))

Range	Resolution	Accuracy	Overload protection
600.0Ω	0.1Ω	The buzzer will give a sound in case of less than 50 Ω, and will not give a sound in case of more than 50 Ω	600V DC 600V AC

7. Diode measuring (→)

Range	Resolution	Accuracy	Overload protection
6.000V/ 10.00V	0.001V	Open-circuit voltage for UT219E is about 10 V, the voltage value for voltage stabilizing diode can be measured (less than 9 V), which can measure the PN junction with the positive voltage drop of 3 V and less. The normal voltage value for Silicon PN junction is about 0.5 to 0.8 V.	600V DC 600V AC

8. Capacitance measurement

Range	Resolution	Accuracy	Overload protection
60.00nF	0.01nF	± (4.0%+30)	600V DC 600V AC
600.0nF	0.1nF	± (4.0%+7)	
6.000uF	0.001uF		
60.00uF	0.01uF		
600.0uF	0.1uF		
6.000mF	0.001mF	± 10%	
60.00mF	0.01mF		

In case of capacitance to be measured $\leq 1\mu\text{F}$, it is suggested that the accuracy of measurement can be guaranteed only by using the REL measurement mode.

9. Frequency

Range	Resolution	Accuracy	Overload protection
60.00Hz~ 10.00MHz	0.01Hz~ 0.01MHz	± (0.1%+6)	600V DC 600V AC

The requirement for input amplitude (a) should be met in frequency measurement:

$\leq 100\text{ kHz}$: $200\text{ mVrms} \leq a \leq 30\text{ Vrms}$
 $> 100\text{ kHz} \sim 1\text{ MHz}$: $600\text{ mVrms} \leq a \leq 30\text{ Vrms}$
 $> 1\text{ MHz} \sim 10\text{ MHz}$: $1\text{ Vrms} \leq a \leq 30\text{ Vrms}$
 $> 10\text{ MHz}$: $1.8\text{ Vrms} \leq a \leq 30\text{ Vrms}$

10. Duty ratio measurement

Range	Resolution	Accuracy	Overload protection
0.1%~99.9%	0.1%	$\pm (2.6\%+7)$	600V DC 600V AC

Following requirements should be satisfied in duty ratio measurement:

The waveform is square wave, and frequency $\leq 10\text{kHz}$

the amplitude: $2\text{Vpp} \leq \text{Input amplitude} \leq 30\text{Vpp}$

Frequency $\leq 1\text{kHz}$, Duty: 5.0%-95.0%

Frequency $> 1\text{kHz}$, Duty: 30.0%-70.0%

XIII. Maintenance and Repair

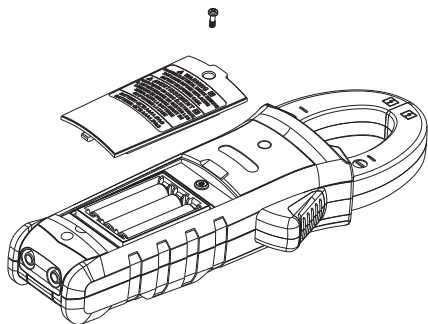

⚠ Warning: Remove the test probes before opening the bottom cover in order to prevent from electric shock.

1. General maintenance

a. The repair and service of this clamp meter should be carried out by qualified professional maintenance staff or authorized repair department.

b. Clean the case regularly with dry cloth, but it is not allowed to use the cleaning agent containing lapping compound or solvent component.

2. Installation or replacement of batteries

The power supply for this product is 3 type AAA 1.5V batteries, please install or replace the batteries by following order:

a. Shut down this product, remove the test probes at input end.

b. With panel of this product facing down, unscrew the battery box screws and pull out the cover, take out the batteries, install the new batteries according to the indication of the polarities.

c. Please use the batteries of the same type, do not install any improper batteries.

d. After installing new batteries, put back the battery cover and fix it with screws.

The contents of this manual are subject to
change without notice.

Manufacturer:
Uni-Trend Technology (China) Limited
No 6, Gong Ye Bei 1st Road
Songshan Lake National High-Tech Industrial
Development Zone, Dongguan City
Guangdong Province
China
Postal Code: 523 808

Headquarters:
Uni-Trend Group Limited
Rm901, 9/F, Nanyang Plaza
57 Hung To Road
Kwun Tong
Kowloon, Hong Kong
Tel: (852) 2950 9168
Fax: (852) 2950 9303
<http://www.uni-trend.com>