

# Constant Current LED Power Supply

SLT20-500IL-UN(for independent use)

SLT20-500IB-UN(for built-in use )

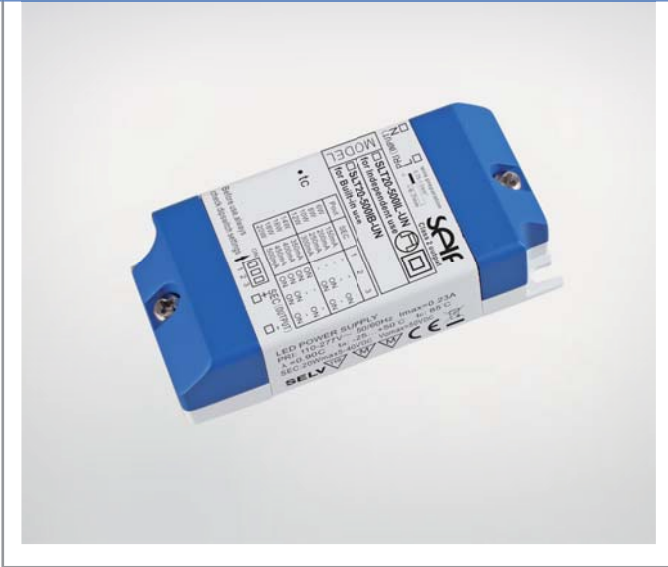

## Standards:

EN61347-1  
 EN61347-2-13  
 EN61547  
 EN55015  
 EN61000-3-2  
 EN61000-3-3  
 EN62384  
 EN62493  
 UL1310  
 FCC 15B

## Product description:

This type of compact constant current power supply with 110-277Vac input voltage has very high efficiency and low power loss.

Designed with high power factor and low output ripple, it can be used either built-in or independently. The output current can be set by the DIP switch, and the output current can be switched every 50mA from 150mA to 500mA.

It conforms to SELV standard and the built-in protection circuit will shut down the converter in case of such faults as: open circuit, short circuit, over load, over temperature. The power supply will restart automatically after fault correction.

## Characteristics:

- Multipower driver supplied with dip-switch for the selection of the output current.
- Class II protection against electric shock for direct or indirect contact
- Driver for built-in or independent use.
- It can be used for lighting equipment in protection class I and II
- Active Power Factor Corrector.
- SELV output(<60V)
- Free flicker design
- Open circuit,short circuit,over load and over temperature protection
- Auto restart after fault conditions removal
- Warranty: 5 years

## Specifications:

Model	SLT20-500IB-UN(for build-in use) SLT20-500IL-UN(for independent use)	
Output	turn on time(S) <sup>①</sup>	≤0.5
	output current(mA) <sup>①</sup>	150/200/250/300/350/400/450/500
	output current tolerance <sup>②</sup>	+/-5%
	ripple current(%) <sup>③</sup>	5%
	working voltage range(V)	Max 42,Min 2V
	output power range(W)	Max 20
	Max. output voltage(V)	48
	output safety rating	SELV
	dimming interface	no dim interface
	dimming range	n/a
Input	rated supply voltage(Vac)	110-277Vac
	voltage range(Vac)	108-305
	line frequency(Hz)	50/60
	input current(mA)	Max 240
	input power(W) <sup>①</sup>	23.8
	efficiency <sup>①</sup>	85%
	power factor <sup>①</sup>	0.90C
	THD <sup>①</sup>	10%
	inrush current(Ipk) <sup>①</sup>	10A/10uS
Protection	input over voltage protection	-
	short circuit protection	yes
	over temperature protection	yes
	automatic restart	yes
	over load protection	yes
	surge capacity	L-N: 1KV
Ambient and Life	Ta(°C)	-20...+50
	Tc max. (°C)	85
	nominal life-time(hrs)	50'000@Ta=50 C
	guarantee(years)	5
	MTBF(hrs)	50'0000
	Storage Temperature(°C)	-30...80
	ambient humidity range	5%...85%RH, Not condensing
	audible noise(dB)	24dBA tested@10cm
Other	weight(g)	85
	dimensions (LxWxH)(mm)	66.7x41x22/85.3x41x22
	casing material	Plastic
	housing colour	Grey+Blue
	connecting method	Terminal block
	type of protection	IP20
	protection class	CLASSII
Note	1. At 230Vac,50Hz,full load. 2. Tolerance:includes set up tolerance,line regulation and load regulation. 3. At 230Vac,50Hz,LED load,below 200Hz	

**Dimensions(mm):**

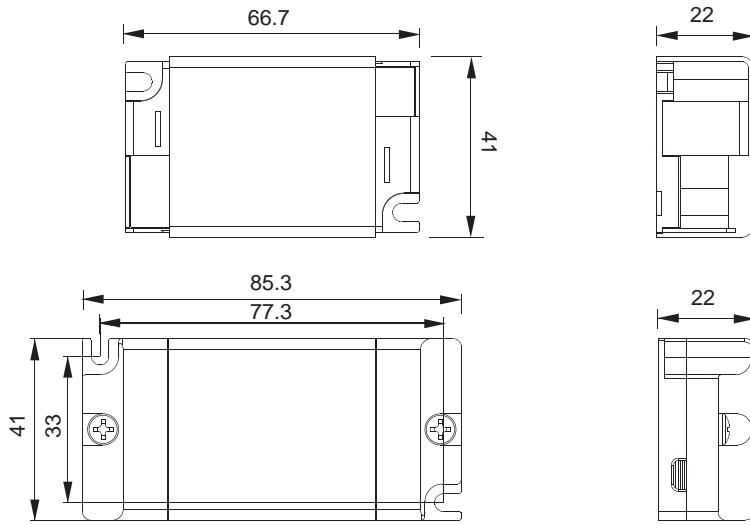

**Wiring diagram:**

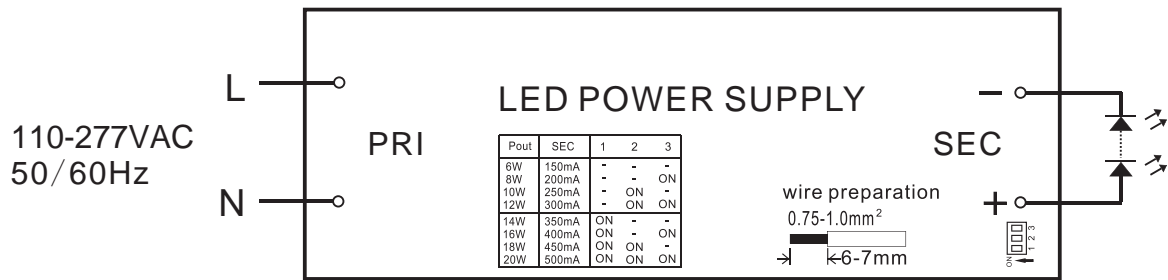

**Application:**

Built-in application



Independent application



Electrical curves:

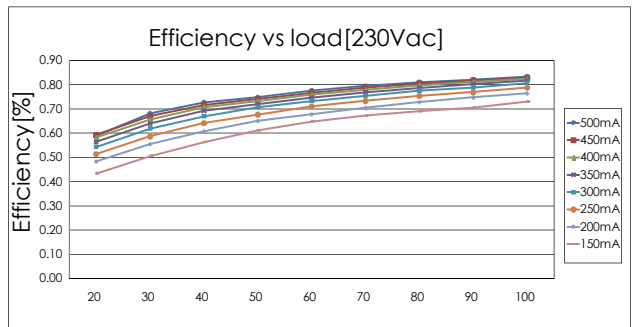
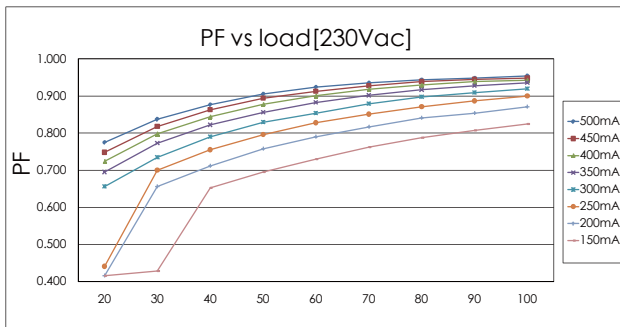
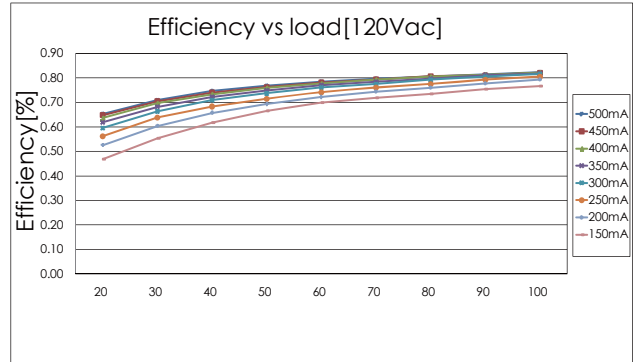
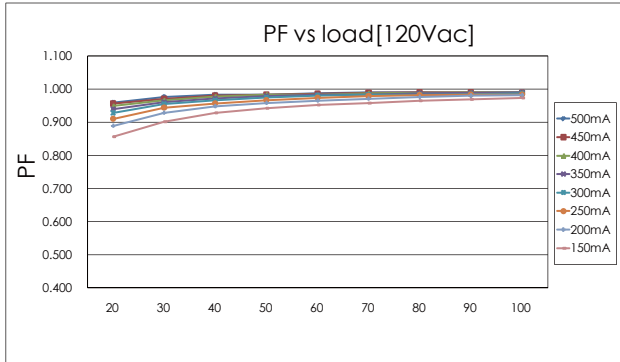

note

For constant current power supply, "LOAD" means the percentage of the maximum rated output voltage.  
 For constant voltage power supply, "LOAD" means the percentage of the maximum rated output current.

## Sales & Technical Support:

### **Self Electronics Co.,Ltd.**

Add: No. 1345 Ju Xian Road, Ningbo Hi Tech Park, Ningbo, China

Tel: 0086-574-28805765,28805658(For English Assistance)

0086-574-28805678 (For Chinese Assistance)

Fax: 0086-574-28805656

E-mail: sales@self-ecg.com

<http://www.self-ecg.com>

### **Self Electronics Co.,Ltd.,Shenzhen Office**

Add: Room2007,Xinglang Xuan,Xinghe Mingju,Fuming Road,Futian District,Shenzhen

Tel: 0086-755-83558850, 83558851

Fax: 0086-755-83558840

### **SELF ELECTRONICS GERMANY GMBH**

Add:August-Horch-Str. 7,51149 Koeln

Tel: 0049 2203 18501-0

Fax: 0049 2203 18501-199

E-mail: saleseu@self-electronics.com

\*Due to continuous improvements and innovations,specifications are subjected to change without notice.