

NICKEL METAL HYDRIDE BATTERIES: INDIVIDUAL DATA SHEET

HHR200SCP Cylindrical 4/5SC size (HR 23/34)

Dimensions (with Tube) (mm)

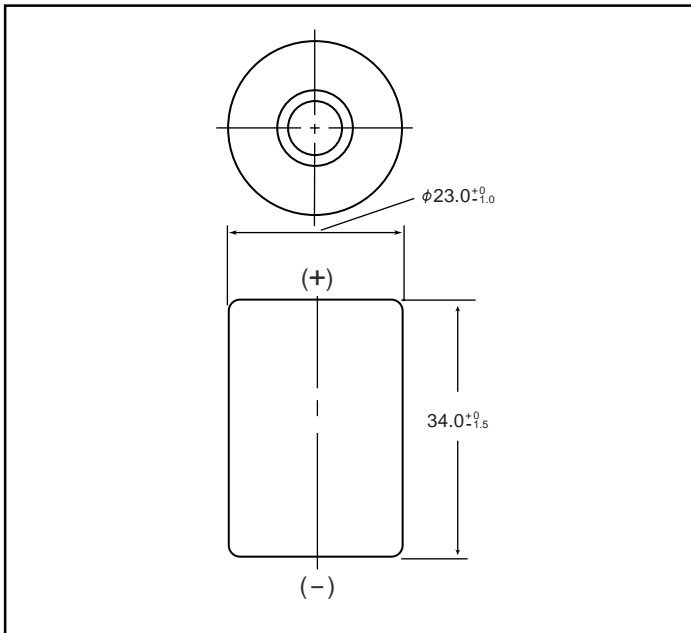

Specifications

	mm	inch
Diameter	23.0+0/-0.1	0.91+0/-0.04
Height	34.0+0/-1.5	1.34+0/-0.06
Approximate Weight	Grams	Ounces
	43	1.52

Nominal Voltage		1.2V		
Discharge Capacity*	Average**	2100 mAh		
	Rated (Min.)	1900 mAh		
Approx. Internal impedance at 1000Hz at charged state.		5mΩ		
Charge	Standard	200mA (0.1It) x 16hrs.		
	Rapid	2000mA (1It) x 1.2 hrs.		
Ambient Temperature	Charge	Standard	°C	°F
			0°C to 45°C	32°F to 113°F
	Rapid	0°C to 40°C	32°F to 104°F	
		Discharge	-10°C to 65°C	14°F to 149°F
Storage	< 2 years	-20°C to 35°C	-4°F to 95°F	
	< 6 months	-20°C to 45°C	-4°F to 113°F	

* After charging at 0.1It for 16 hours, discharging at 0.2It.

** For reference only.

Battery performance and cycle life are strongly affected by how they are used. In order to maximize battery safety, please consult Panasonic when determining charge / discharge specs, warning label contents and unit design.

Note: [It] was previously expressed as [C]. [It] is an IEC standard expression for the amount of charge or discharge current and is expressed as:
 $It(A) = Cn (Ah)/1h.$

- [It] is the reference test current in amperes
- [Cn] is the rated capacity of the cell or battery in Ampere-hours.
 n = the time base [hours] for which the rated capacity is declared

Typical Charge Characteristics

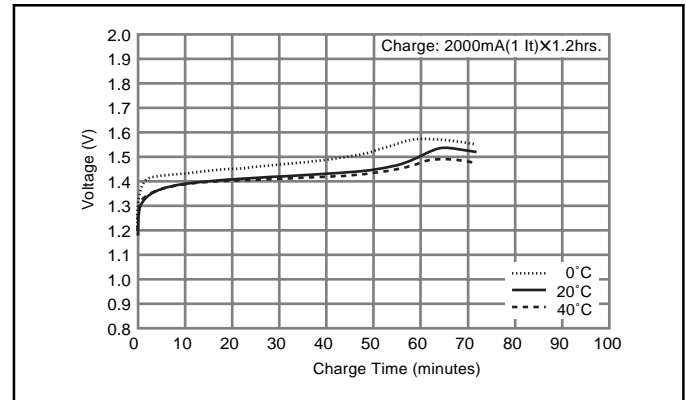

Typical Discharge Characteristics

